

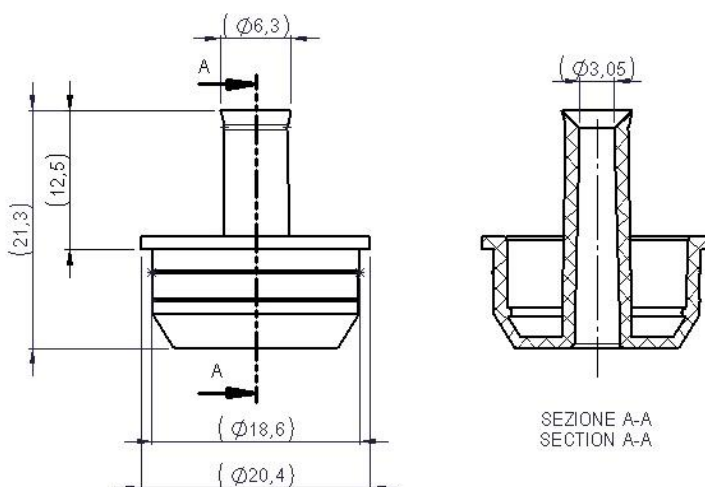







**Art. cod. 00615**
**Descrizione / Description / Description**
**Riduttore  $\varnothing 3$  collo  $\varnothing 18$** 
***Dropper  $\varnothing 3$  necked  $\varnothing 18$*** 
***Réducteur  $\varnothing 3$  col  $\varnothing 18$*** 

**Tabella dati tecnici / Technical data table / Tableau données techniques**

							
$\varnothing$ Esterno (mm)	$\varnothing$ Aggancio a flacone (mm)	$\varnothing$ Esterno punta (mm)	$\varnothing$ Erogazione (mm)	H - Totale (mm)	Hp - Parziale (mm)	Materiale	Peso (g)
$\varnothing$ External (mm)	$\varnothing$ Bottle engagement (mm)	$\varnothing$ Outer tip (mm)	$\varnothing$ Delivery (mm)	H - Total (mm)	Hp - Partial (mm)	Material	Weight (g)
$\varnothing$ Externe (mm)	Engagement de bouteille $\varnothing$ (mm)	$\varnothing$ Pointe extérieure (mm)	$\varnothing$ Livraison (mm)	H - Total (mm)	Hp - Partiel (mm)	Matière	Poids (g)
20,40	18,60	6,30	3,05	21,30	12,50		1,0 $\pm$ 0,10

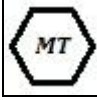
Il peso indicato è puramente indicativo e non valido ai fini CONAI.

The weight indicated is purely indicative.

Le poids indiqué est indicatif.

## Tabella dati imballaggio-spedizione / Table packing and shipping details / Table données d'emballage-expédition

Scatola standard (cm)	Sacchetto	Quantità per scatola	Quantità per pallet	Pallet (cm)
<i>Standard box (cm)</i>	<i>Bag</i>	<i>Pcs box</i>	<i>Pcs pallet</i>	<i>Pallet (cm)</i>
<i>Carton standard (cm)</i>	<i>Sachet</i>	<i>Pcs carton</i>	<i>Pcs palette</i>	<i>Palette (cm)</i>
60x40 H:33,5	PE Food contact	7500	90000	120x80 H:112

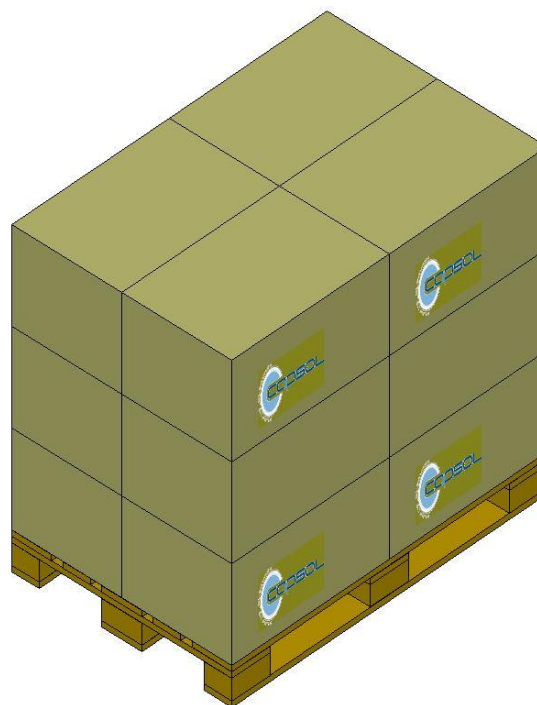

### Stoccaggio / Storage / Stockage

Conservare i prodotti nella loro confezione originale in un luogo pulito, fresco e asciutto.  
*Store the products in their original packaging in a clean, cool and dry place.*  
*Stocker les produits dans leur emballage d'origine dans un endroit propre, frais et sec.*

Temperatura / Temperature / Temperature : **5÷30°C**

Umidità / Humidity / Humidité : **45÷75%**

Conservare i prodotti a temperatura ambiente (**20°C±5**) per **48 ore** prima dell'uso sulla macchina confezionatrice.  
*Store the products at room temperature (20°C±5) for 48H before using on packaging machine.*  
*Stocker les produits à température ambiante (20°C±5) pendant 48 heures avant l'utilisation sur la machine d'emballage.*