

Art. cod. 00664







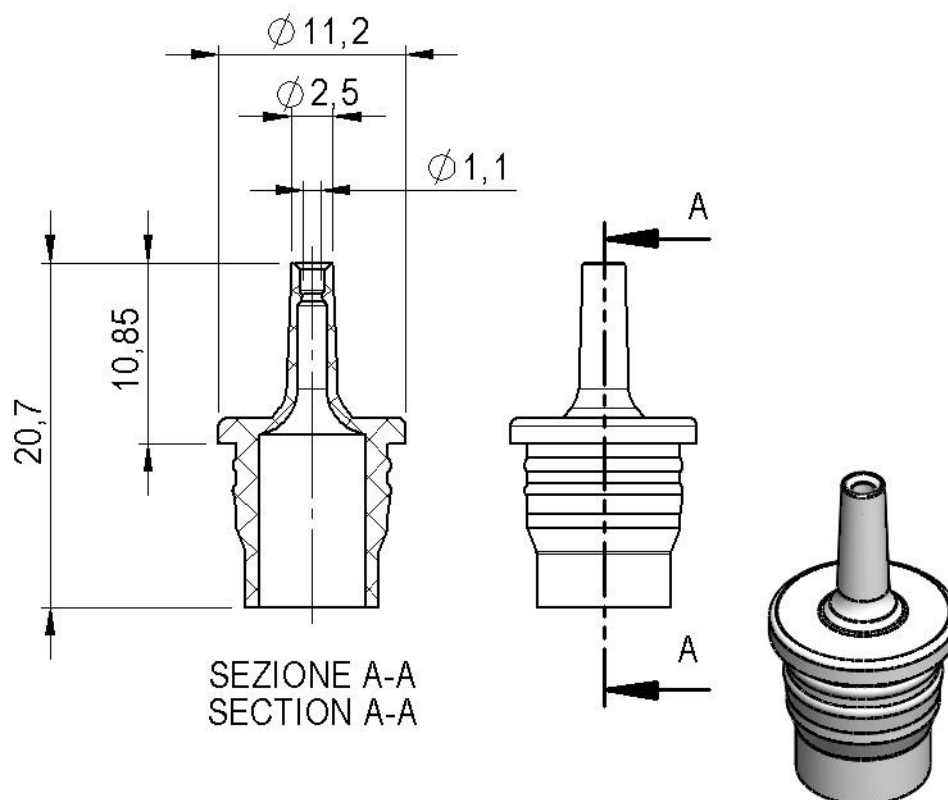

Descrizione / Description / Description

Contagocce

Compte-gouttes

Dropper

**Tabella dati tecnici / Technical data table / Tableau données techniques**

							
Ø Esterno (mm)	Ø Aggancio a flacone (mm)	Ø Esterno punta (mm)	Ø Erogazione (mm)	H - Totale (mm)	Hp - Parziale (mm)	Materiale	Peso (g)
Ø External (mm)	Ø Bottle engagement (mm)	Ø Outer tip (mm)	Ø Delivery (mm)	H - Total (mm)	Hp - Partial (mm)	Material	Weight (g)
Ø Externe (mm)	Engagement de bouteille Ø (mm)	Ø Pointe extérieure (mm)	Ø Livraison (mm)	H - Total (mm)	Hp - Partiel (mm)	Matière	Poids (g)
Ø11,2	Ø9,5	Ø2,5	Ø1,1	20,70	10,85		0,4 ±0,1

Il peso indicato è puramente indicativo e non valido ai fini CONAI.

The weight indicated is purely indicative.

Le poids indiqué est indicatif.

## Tabella dati imballaggio-spedizione / Table packing and shipping details / Table données d'emballage-expédition

Scatola standard (cm)	Sacchetto	Quantità per scatola	Quantità per pallet	Pallet (cm)
<i>Standard box (cm)</i>	<i>Bag</i>	<i>Pcs box</i>	<i>Pcs pallet</i>	<i>Pallet (cm)</i>
<i>Carton standard (cm)</i>	<i>Sachet</i>	<i>Pcs carton</i>	<i>Pcs palette</i>	<i>Palette (cm)</i>
38x38 H:33	PE Food contact	18000	324000	120x80 H:110,5

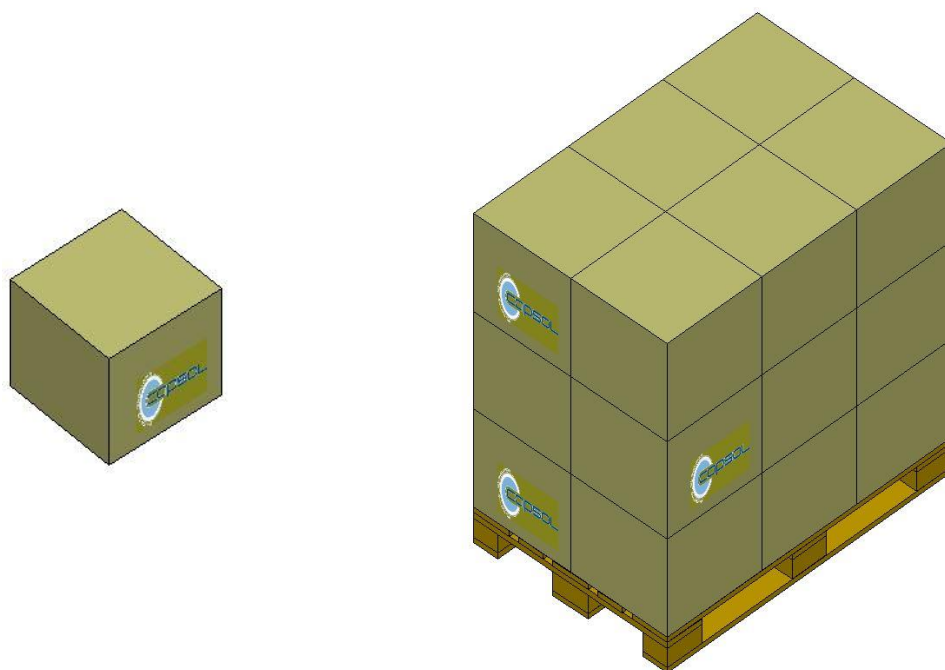

### Stoccaggio / Storage / Stockage

Conservare i prodotti nella loro confezione originale in un luogo pulito, fresco e asciutto.

*Store the products in their original packaging in a clean, cool and dry place.*

*Stocker les produits dans leur emballage d'origine dans un endroit propre, frais et sec.*

Temperatura / Temperature / Temperature : **5÷30°C**

Umidità / Umidity / Umidité : **45÷75%**

Conservare i prodotti a temperatura ambiente (**20°C±5**) per **48 ore** prima dell'uso sulla macchina confezionatrice.

*Store the products at room temperature (20°C±5) for 48H before using on packaging machine.*

*Stocker les produits à température ambiante (20°C±5) pendant 48 heures avant l'utilisation sur la machine d'emballage.*