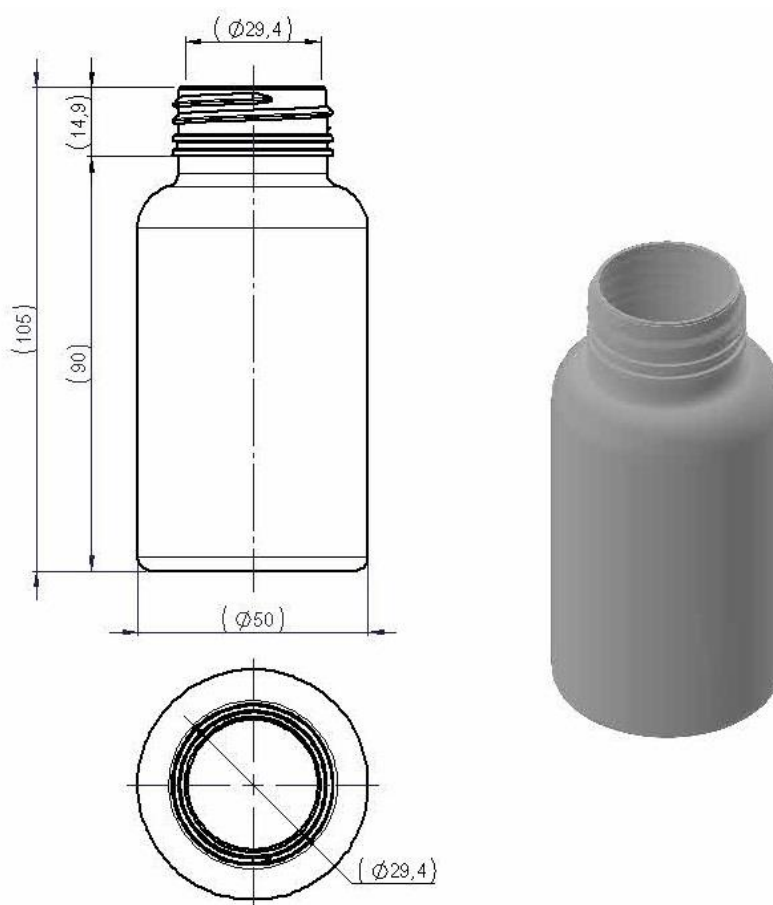
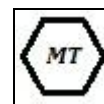

Art. cod. 01F137
Descrizione / Description / Description
Pilloliera PE 150ml PFP35
Bottle pillbox PE 150ml PFP 35
Flacon PE 150ml PFP 35

Tabella dati tecnici / Technical data table / Tableau données techniques

Tipo filetto	Passo filetto (mm)	N° Principi filetto	Capacità raso bocca	Materiale	Masterbatch	Peso (g)
Thread type	Thread pitch (mm)	N° Thread starts	Brimfull capacity	Material	Masterbatch	Weight (g)
Type filet	Pass de filet (mm)	N° Pass de vis filet	Contenance ras-bord	Matière	Masterbatch	Poids (g)
PFP35	-	-	160,0 ±3,5	PE Food contact	Food contact	17,0 ±1,0

Il peso indicato è puramente indicativo e non valido ai fini CONAI.

The weight indicated is purely indicative.

Le poids indiqué est indicatif.

Tabella dati imballaggio-spedizione / Table packing and shipping details / Table données d'emballage-expédition

Scatola standard (cm)	Sacchetto	Quantità per scatola	Quantità per pallet	Pallet (cm)
Standard box (cm)	Bag	Pcs box	Pcs pallet	Pallet (cm)
Carton standard (cm)	Sachet	Pcs carton	Pcs palette	Palette (cm)
57x37 H:56	PE Food contact	320	5120	120x80 H:239

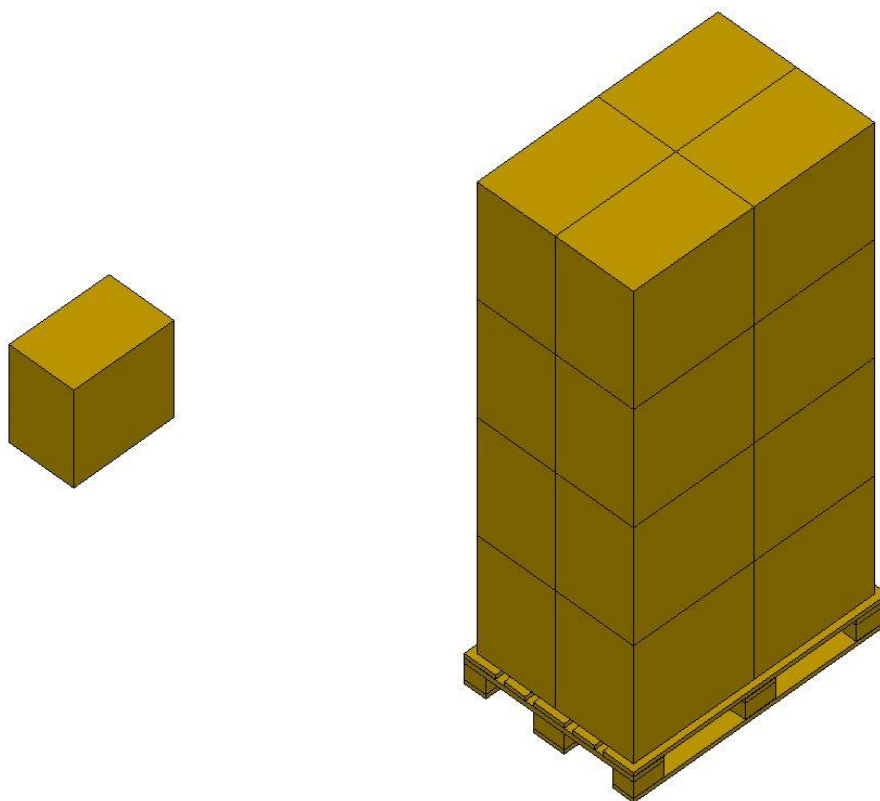

Stoccaggio / Storage / Stockage

Conservare i prodotti nella loro confezione originale in un luogo pulito, fresco e asciutto.

Store the products in their original packaging in a clean, cool and dry place.

Stocker les produits dans leur emballage d'origine dans un endroit propre, frais et sec.

Temperatura / Temperature / Temperature : **5÷30°C**

Umidità / Umidity / Umidité : **45÷75%**

Conservare i prodotti a temperatura ambiente (**20°C±5**) per **48 ore** prima dell'uso sulla macchina confezionatrice.

*Store the products at room temperature (**20°C±5**) for **48H** before using on packaging machine.*

*Stocker les produits à température ambiante (**20°C±5**) pendant **48 heures** avant l'utilisation sur la machine d'emballage.*